

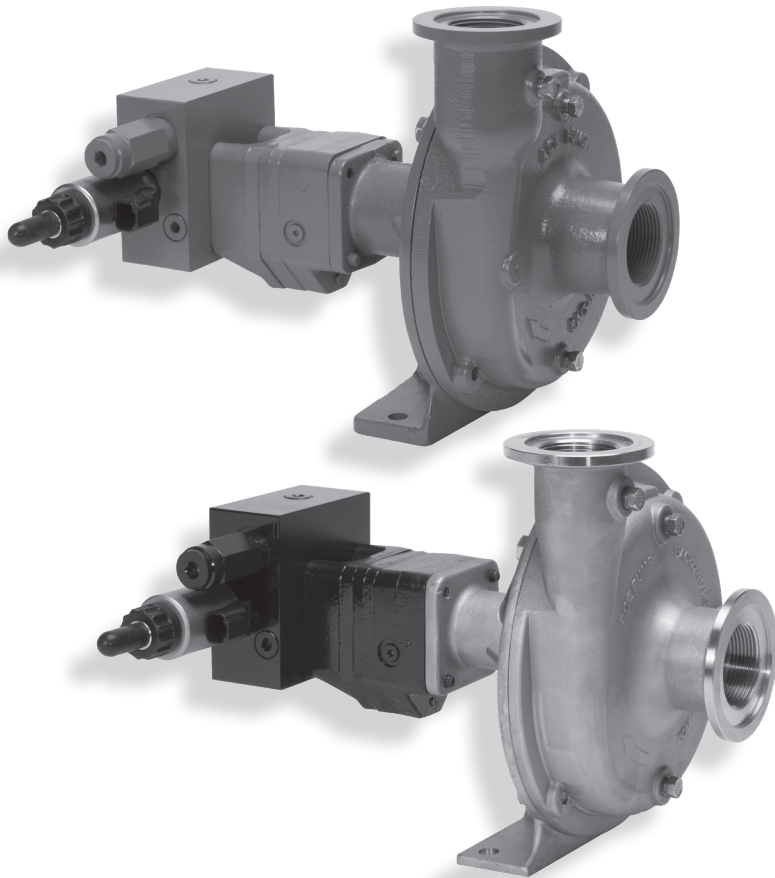

Hydraulic Driven Pump with Integrated PWM Control Valve



FMCSC-150F-HYD-206-PWM FMCSC-150FS-HYD-206-PWM

- Suction 220 Flange & 1-1/2" NPT
- Discharge 200 Flange & 1-1/4" NPT
- -FS Model - 316 Stainless Steel
- Integrated Proportional 12V Control Valve for Precision Ag applications using Pulse Width Modulated (PWM) control signals
- Integrated Pressure Relief Valve prevents overspeeding
- For the following Hydraulic Systems:
 - ✓ Pressure Compensating Closed Center
 - ✓ Load Sensing or Pressure Flow Compensating Closed Center
- Severe Duty Silicon Carbide Mechanical Seal
- Chemical Resistant Thermoplastic Impeller

PERFORMANCE CHART

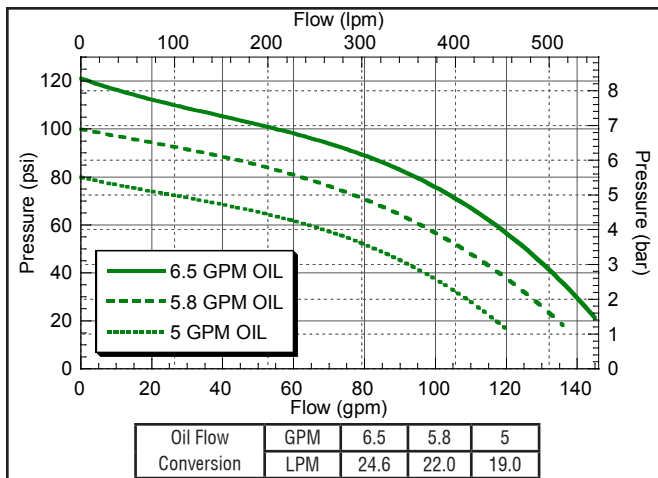

DIMENSIONS

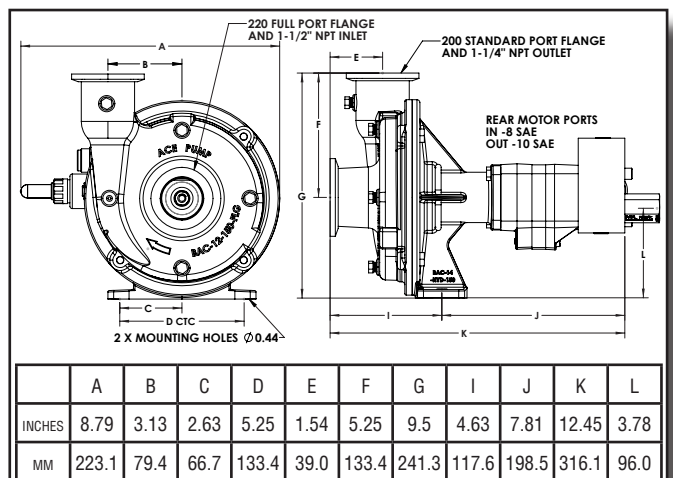



FMCSC-150F-HYD-206-PWM FMCSC-150FS-HYD-206-PWM

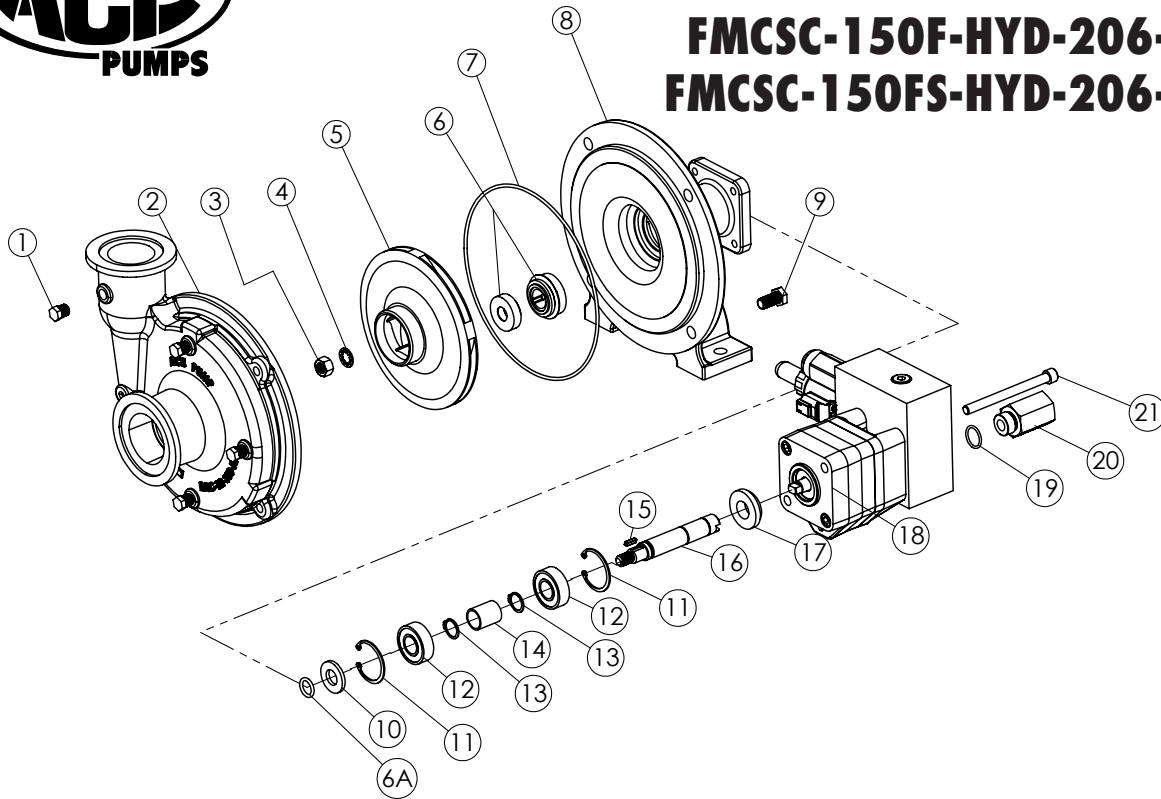

REF #	PART NUMBER	EDP#	DESCRIPTION	REQ.
1	BAC-53	41110	Pipe plug	4
1	41120	41120	Pipe plug, stainless steel (optional)	4
2	BAC-12-150-FLG	40257	Volute, 1-1/2" NPT & 220 flange x 1-1/4" NPT & 200 flange	1
2	BAC-12-150-SS	40249	Volute, 316 stainless steel, NPT & flanged (-FS model)	1
3	BAC-23-B-SS	40393	Nut, 3/8" NF, SS	1
4	BAC-24-B-SS	42702	Washer, 3/8" SS, vibration proof	1
5	BAC-26-150-P	40446	Impeller, thermoplastic, key way	1
5	BAC-26-150-CI	40445	Impeller, cast iron, keyway (optional)	1
5	BAC-26-150-PI	40448	Impeller, polypropylene, keyway (optional)	1
5	BAC-26-150-SS	40449	Impeller, SS, keyway (optional)	1
6 ^①	BAC-7V	40151	Seal, mechanical, carbon/ceramic (includes 40160 O-ring)	1
6 ^②	BAC-7SC	40152	Seal, mechanical, silicon carbide (includes 40160 O-ring) (optional)	1
6A ^{①②}	40160	40160	O-ring, shaft seal	1
7 ^①	BAC-4-150	40015	O-ring, body seal	1
8	BAC-14-150-HYD	40305	Mounting frame (for 206 Series hydraulic motor)	1
8	BAC-14-150-HYD-SS	40319	Mounting frame, 316 stainless steel (-FS model)	1
9	40950	40950	Cap screw, 3/8" NC x 3/4" hex head	4
9	40930	40930	Cap screw, 3/8" NC x 3/4" hex head, stainless steel (optional)	4
10	BAC-54	41130	Slinger	1
11	BAC-33	40810	Snap ring, internal, BAC-14 mounting frame	2
12	BAC-37	40870	Ball bearing, sealed, BAC-6 shaft	2
13	BAC-32	40790	Snap ring, external, BAC-6 shaft	2
14	BAC-32-S	40795	Spacer for BAC-6 shaft	1
15	BACH-25	40420	Key, 1/8" x 1/8" x 1/2"	1
16	BAC-6-HYD-SS	40061	Shaft, 5/8" diameter, keyway and tang slot, stainless steel	1
17	S200	40161	Seal support spacer for 200 Series HYD motor	1
18	BAC-75-HYD-206-PWM	41324	Hydraulic motor, 6.5 GPM (24.6 LPM), with integrated valve	1
19	41875	41875	O-ring, #8 SAE fitting	1
20	BAC-78-10X8SAE	41462	Reverse check assembly, #10 SAE x #8 SAE	1
21	41261	41261	5/16" NC 6" Socket head cap screw for 206-PWM	2
①	RK-FMC-150	52710	Repair kit for FMC-150 series pump	1
②	RK-FMCSC-150	52711	Repair kit for FMC-150 series pump with silicon carbide seal	1
*	RK-BAC-75-HYD-L	41362	Repair kit for L series motor	1

* Not shown



BAC-75-HYD-206-PWM

HYDRAULIC MOTOR PARTS LIST

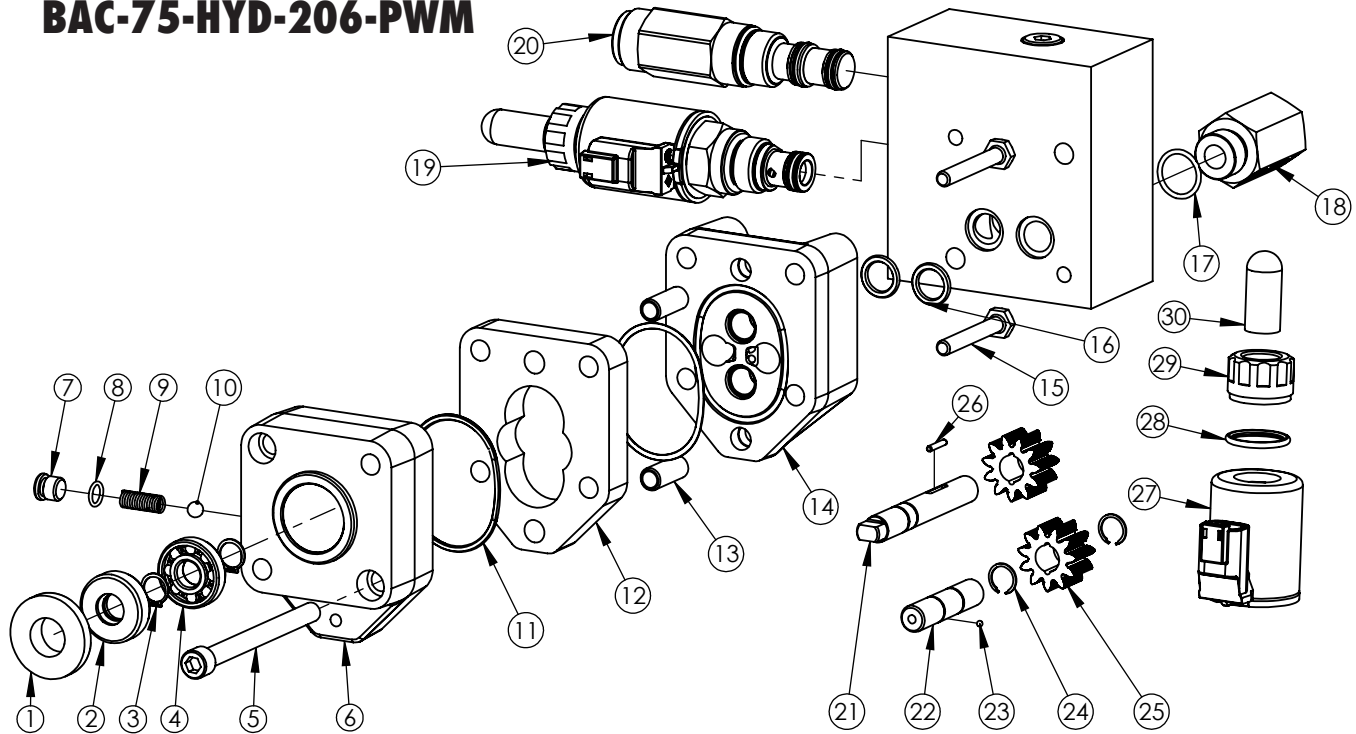

REF #	PART NUMBER	EDP#	DESCRIPTION	REQ.
1	S200	40161	Seal support spacer	1
2 ^①	BAC-75-200-TLS	40153	Seal cartridge	1
3	41941	41941	Snap ring, bearing	2
4	41961	41961	Ball bearing, 7/16" I.D.	1
5	41256	41256	Cap screw, 5/16" N.C. x 3.5" socket head	2
6	41731	41731	Drive plate, 200 series motors	1
7	42041	42041	Valve cap, coasting check	1
8 ^①	42044	42044	O-ring, coasting check	1
9	42042	42042	Spring, coasting check	1
10	42043	42043	Ball, coasting check	1
11 ^①	41850	41850	O-ring, housing seal	2
12	41721	41721	Gear housing	1
13	41801	41801	Dowel pin, housing	2
14	41746	41746	End plate, 200-PWM series motors	1
15	41900	41900	Cap screw	2
16	74209	74209	O-ring, port sealing, manifold to motor	2
17	41875	41875	O-ring, #8 SAE male fitting	2
18	BAC-78-10X8 SAE	41462	Reverse check, #8 SAE male x #10 SAE female	1
19	PWM-18-PRO-6	74222	Valve assembly, 12V proportional	1
20	PWM-18-PRV-11	74210	Valve assembly, pressure reducing	1
21	41764	41764	Drive shaft	1
22	41971	41971	Idler shaft	1
23	41990	41990	Ball, idler shaft	1
24	41980	41980	Retaining ring, idler gear	2
25	41751	41751	Gear	2
26	41921	41921	Dowel pin, drive shaft	1
27	74225	74225	Coil, 12V for PWM-18-PRO-6 and -11	1
28	41445	41445	O-ring, coil nut	1
29	74230	74230	Nut, coil retainer for PWM-18-PRO-6 and -11	1
30	74235	74235	Protector, manual override, PWM-18-PRO-6 and -11	1
31	BAC-75-HYD-206P	41321	Motor, BAC-75-HYD-206-PWM, less manifold	-
*	PWM-1-206	74201	Mainfold assembly, 206-PWM, includes 16 - 20	-
①	RK-BAC-75-HYD-L	41374	Motor repair kit	-

* Not shown

REGULATING HYDRAULIC FLOW TO THE SPRAYER PUMP

There are three general types of hydraulic systems:

- 1) Load Sensing (LS), also known as Pressure-Flow Compensating (PFC) Closed Center
- 2) Pressure Compensating Closed Center (PC)
- 3) Open Center (OPEN)

This product is designed to operate on both Closed Center Hydraulic Systems. It should not be used with Open Center systems. Please consult the Tractor Hydraulic System Pump Selection Guide(HSG), Internet Hydraulic Selection Guide (IHSG) at www.AcePumps.com, or your tractor dealer to determine your tractor's hydraulic system.

The two valve design limits the maximum oil flow to the motor and prevents overspeeding. So the Restrictor Orifice and Flow Limiter are not needed with this product.

All PWM controllers are slightly different in the terminology used and setup procedures. Please consult your controller documentation or their technical service department for additional assistance with your specific application and implement in use.

Link to Ace Pump
IHSG

<http://www.acepumps.com/ihsg/>



Link to Ace Pump
PWM Technical File

http://www.acepumps.com/_Assets/Literature/PWM_Technical_File.pdf





















HSG Homepage
ACE Pumps Website



Internet Hydraulic Selection Guide

Simply select a tractor make on this page and the model number from the following page. The system will then display which ACE pump models to use.

You may also choose to print the results of your search along with the setup instructions for your hydraulic system type.

ACE PUMP CORPORATION
P.O. Box 13187 • 1650 Channel Avenue • Memphis, TN 38113
Phone: (901) 948-8514 • Fax: (901) 774-6147



PWM Technical File

Updated 12/2015

PWM Control Basics and Terminology

PWM (Pulse Width Modulated) control systems are being used widely in modern liquid applications. The use of this technology is driven by the need in agriculture for precision application of fertilizers and chemicals. The goal is to apply what is needed at the correct time while minimizing input cost, preventing runoff which may contaminate water supplies, and eliminate drift.

The PWM signal is an efficient technique to control current to a proportional electrical hydraulic valve. The PWM signal switches on and off to achieve the required control current (see Figure 1). The duty cycle "D" refers to the "on" portion of the cycle. The duty cycle can be anywhere from 0 (signal always off) to 1 (signal always on).

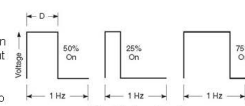

Figure 1

Dither is a rapid, small variation in the control signal designed to keep the valve spool in motion. This movement is intended to avoid **stiction** and average out **hysteresis**.

Stiction keeps the valve spool from moving when control signal changes are small. When the valve spool finally moves it can overshoot the correct position.

Hysteresis is the tendency for the spool movement to be different if the signal is increasing or decreasing. This can happen even with the identical control signal.

Valve Settings & Performance

I-Min or Minimum PWM is the minimum control current induced into the control valve. This is typically set to the point where the control signal creates a response from the valve spool. For Ace Pumps, this is typically set to the point when our pump starts to turn or where a minimum application pressure is achieved. This eliminates the **Deadband** which is typical for all control valves (see Figure 2).

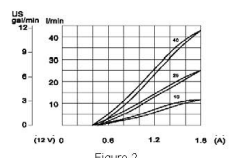

Figure 2
Typical Valve Performance Graph

I-Max or Maximum PWM is the maximum control current supplied to the control valve. This is typically set to the point where the control signal results in maximum performance. For Ace Pumps, set this to achieve the maximum shut-off pressure recommended for the pump model.

P.O. BOX 13187 • 1650 CHANNEL AVENUE • MEMPHIS, TN 38113